

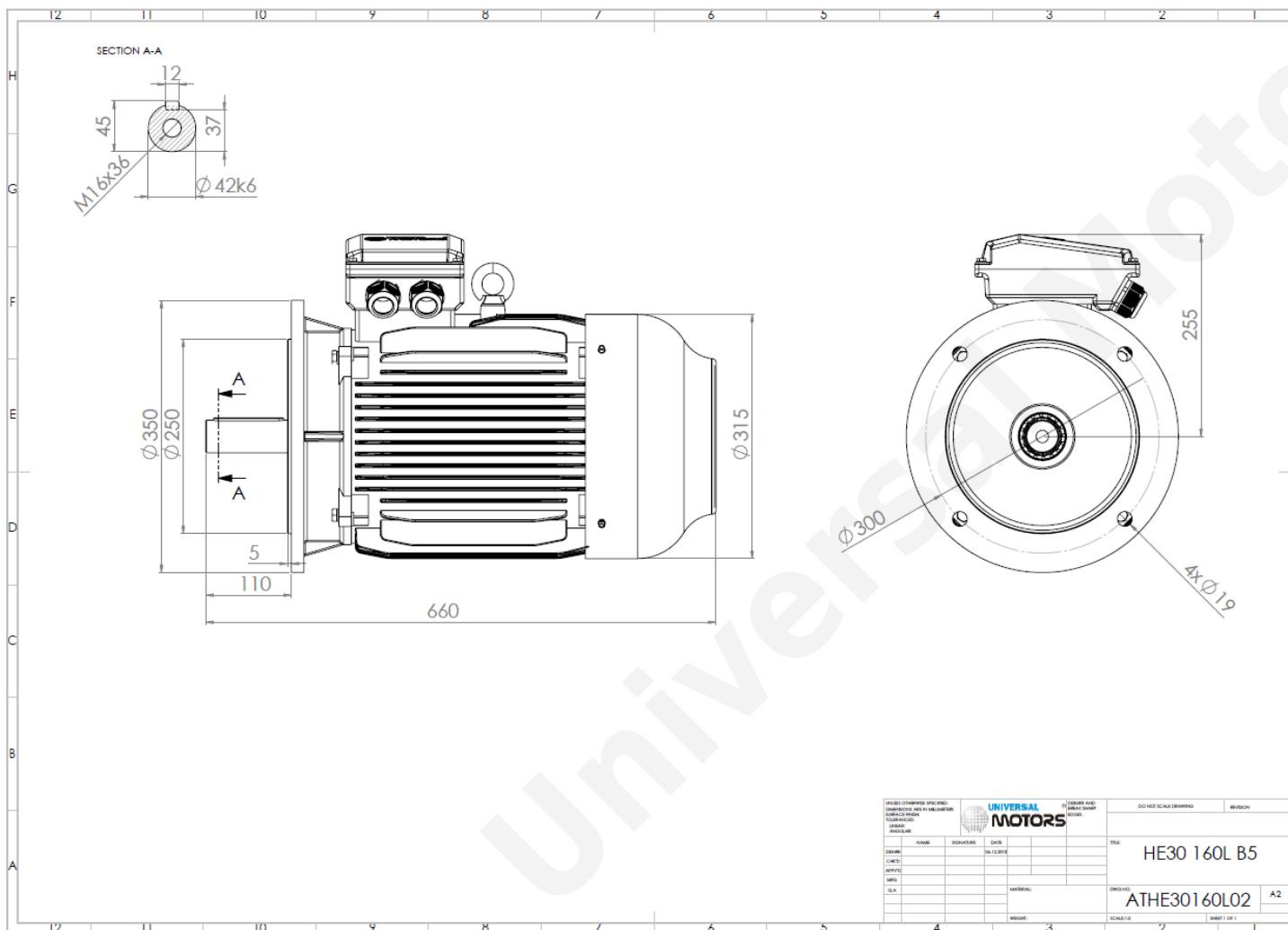

TECHNICAL DATA

Three Phase Electric Motors - Cast Iron Frame
 HE30 160 L1 6 IE2
 11 kW / 15 Cv
 970 RPM



Motor type:	HE30 160 L1 6 IE2
Output:	11 kW / 15 Cv
Speed (min ⁻¹):	970 RPM
Frequency:	50 Hz
Voltage:	400 V
Current:	22.7 A
Power factor (Cos Ø):	0.79
Poles:	6
Insulation class:	F
Temperature rise Class:	B
Efficiency 50%:	88.2 %
Efficiency 75%:	89.1 %
Efficiency 100%:	88.7 %
Torque:	108 N.m
Tstarting/Tnominal:	2.1
Istarting/Inominal:	6.9
Tmaximum/Tnominal:	2.1
Noise:	62 Db(A)
Weight:	148 Kg
Bearing DE:	6309 C3
Bearing NDE:	6309 C3

UNIVERSAL MOTORS		DO NOT SCALE DRAWING		REVISION
DESIGNER	DATE	SCALE	SHEET 1 OF 1	
HE30 160L B5	04.10.2016	1:1		
ATHE30160L02				

Regime - S1

Altitude - 1000m

Environment Temperature - 40°C

CONTACTS:

UNIVERSAL MOTORS Tel: +351 252 299 080
 Rua de São Brás,745 Fax: +351 252 299 089
 4480-782 VILA DO CONDE Mail: geral@universalmotors.pt

* References applied only in the UK